

**COOLMASTER** *OFFROAD*

# External Transmission Oil Cooler Kit Suitable for:



**Nissan Patrol Y62 with RE7  
7 Speed Automatic Transmission**

**WITH VK56 - 5.6L V8 PETROL ENGINE (2010-ON)**

*Please read through all of the instructions carefully before proceeding.  
If any of the information does not appear correct or the diagrams don't  
match your vehicle, please contact your local ALLTRANZ branch.*

## Parts List:



2 x 5/16" Coolers plus  
1 x Custom Bracket



1 x M8 x 20 SEMS Bolt



1.5m x 5/16" Cooler Line  
Hose with Conduit



0.5m x 5/16" Dual  
Cooler Link Hose



1 x M6 x 20 SEMS Bolt



6 x 8-16 Screw Clamps

**Expected Installation Time: ~ 2 Hours**

## Summary of Installation - For Experienced Fitters

- *SAFETY FIRST: Allow engine, auto and fluid to cool prior to starting work to prevent serious injury.*
- *Remove grill.*
- *Remove the right-hand horn but leave wiring connected.*
- *Remove the nut off the stud that is mounting the airbag sensor*
- *Remove battery and battery tray to allow easier access to cooler hose routing*
- *For easier installation we will be plumbing the Dual Cooler before the OEM Cooler*
- *Remove lower hose of the original cooler*
- *Fit new 8mm hose supplied in kit. (Do not cut into 2 lengths yet)*
- *With hose in/outlets facing the drivers side of the vehicle, mount the cooler to the original horn mounting hole (OEM Bolt), Airbag Sensor stud (OEM Nut), and the flat section of the lower radiator support (supplied M6x20 SEMS bolt).*
- *Fit hose that is coming from the pipe mounted on the radiator to the top of the rear cooler. Cut hose to length and use new supplied clamp*
- *Fit hose that is on the OEM transmission cooler to the bottom of the front cooler. Cut hose to length and use new supplied clamp.*
- *Fit supplied 500mm Dual Cooler Connection hose to the remaining in/outlets on the front cooler and the rear cooler.*
- *Before refitting horn, rotate bracket 180° and re-tighten. (Horn outlet needs to be facing down so it doesn't collect water).*
- *Mount horn to the new cooler bracket with supplied M8x20 SEMS bolt.*
- *Refit battery tray and battery.*
- *Check transmission oil level*
- *Check for leaks*
- *Refit grill.*
- *Check clearance of hoses and fittings to any other moving/hot part.*
- *Test drive vehicle for 10mins*
- *Recheck transmission fluid level and also check all hoses and fittings for leaks. If transmission fluid low, redo road test and check again.*
- *Refit any bash plates, grills, aftermarket accessories removed.*
- *Clean any oil residue off vehicle.*

## Detailed Installation Instructions

**Before commencing work, please ensure that you have sufficient transmission fluid and to top up at the end of the job.**

1. Remove any bash plates that are covering/protecting the radiator.
2. Remove the eight plastic clips holding the top shroud in place.



3. Pull forward gently on left and right sides of grill as they are held in with push clips.

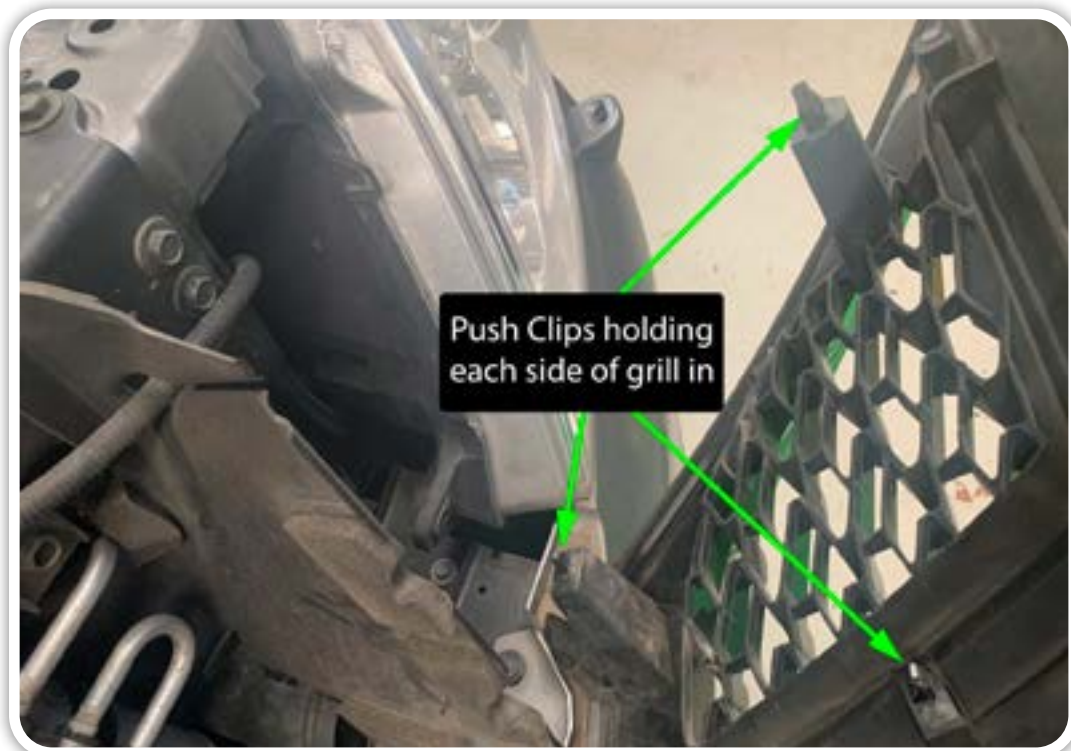

4. Unclip six flat grill clips at the bottom of the grill by lifting up on the clip.

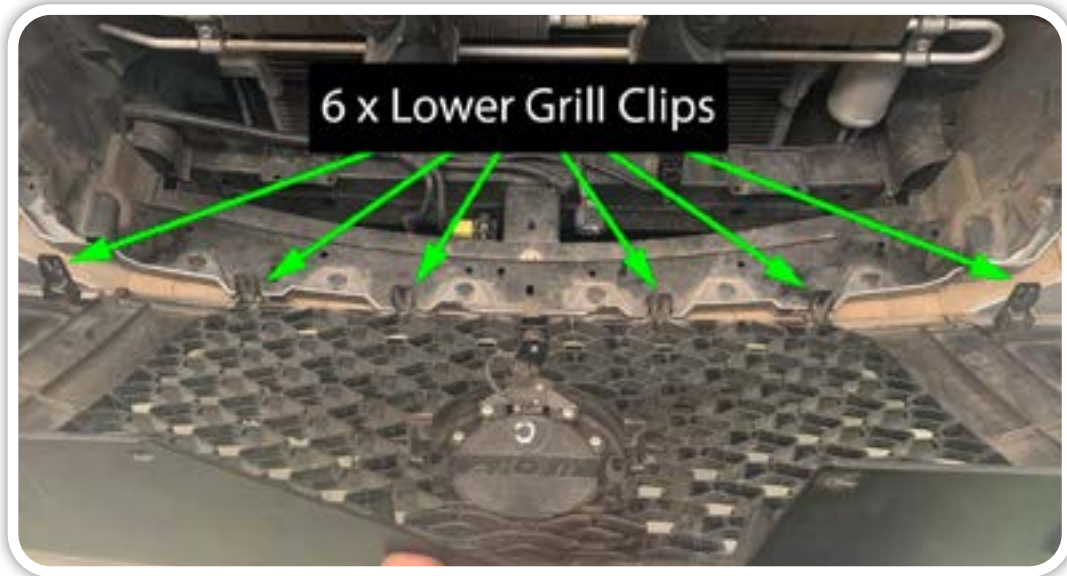

5. Remove battery and battery tray to allow easier access for removing OEM cooler hose and routing new cooler hose. Battery tray is held in by four (4) M8 Bolts and the bonnet cable clip.

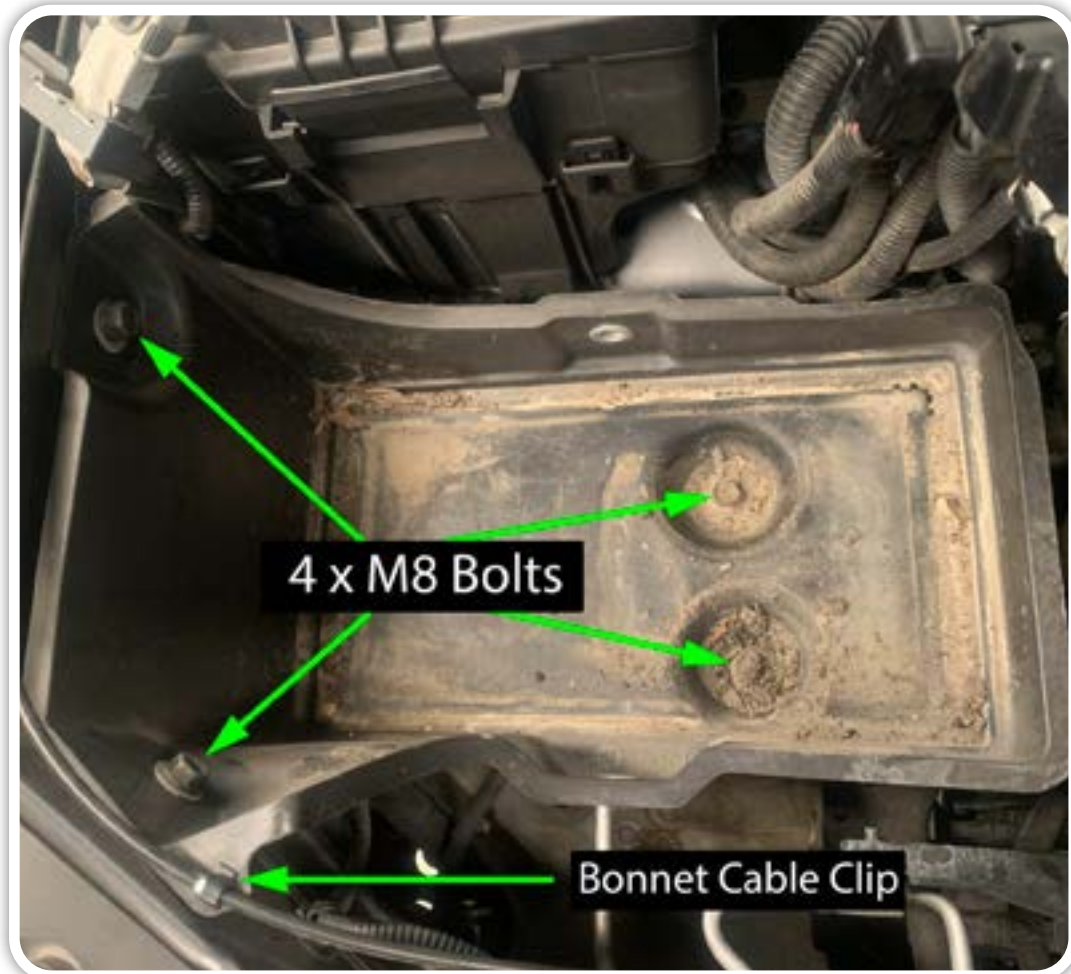

6. Remove the drivers side horn but leave wiring connected.



7. Remove the nut off the stud that is mounting the airbag sensor.

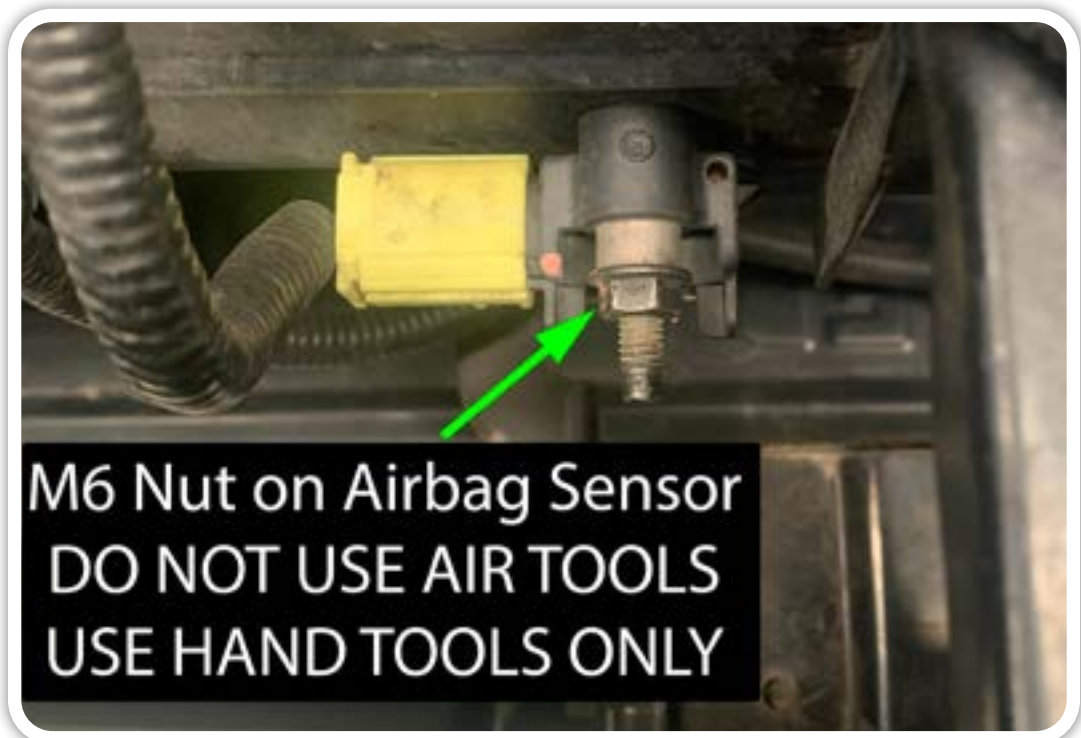

8. For easier installation the new Dual Cooler will be plumbed into the flow before the OEM cooler.

9. Remove clamps off the lower hose of the original cooler. Trace through radiator support to the other end of the rubber line. Remove clamp and then remove the OEM cooler hose.

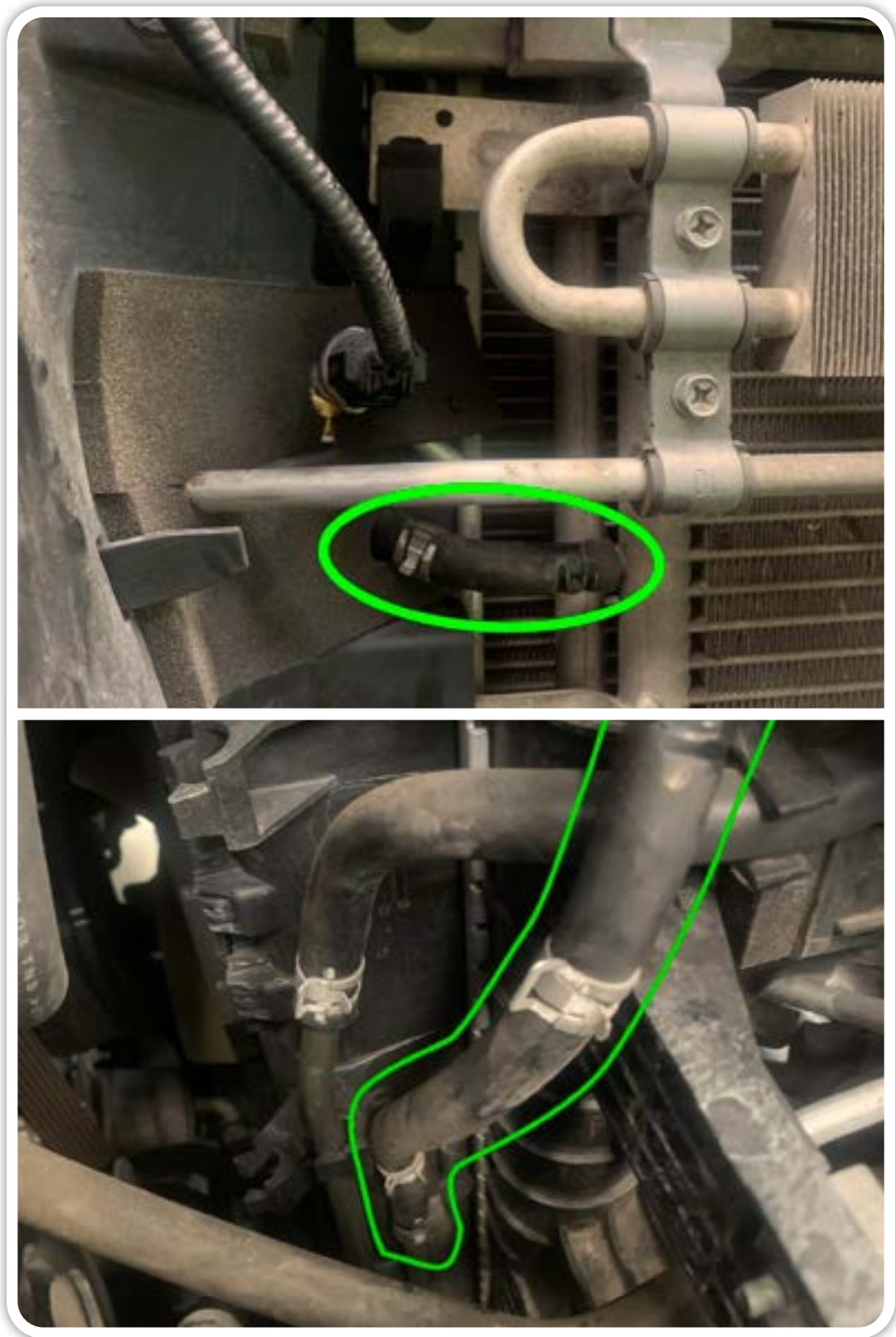

- 10.** Fit new 8mm hose supplied in kit to the OEM in/outlets from removed OEM Hose. (Do not cut new hose into 2 separate lengths yet.)

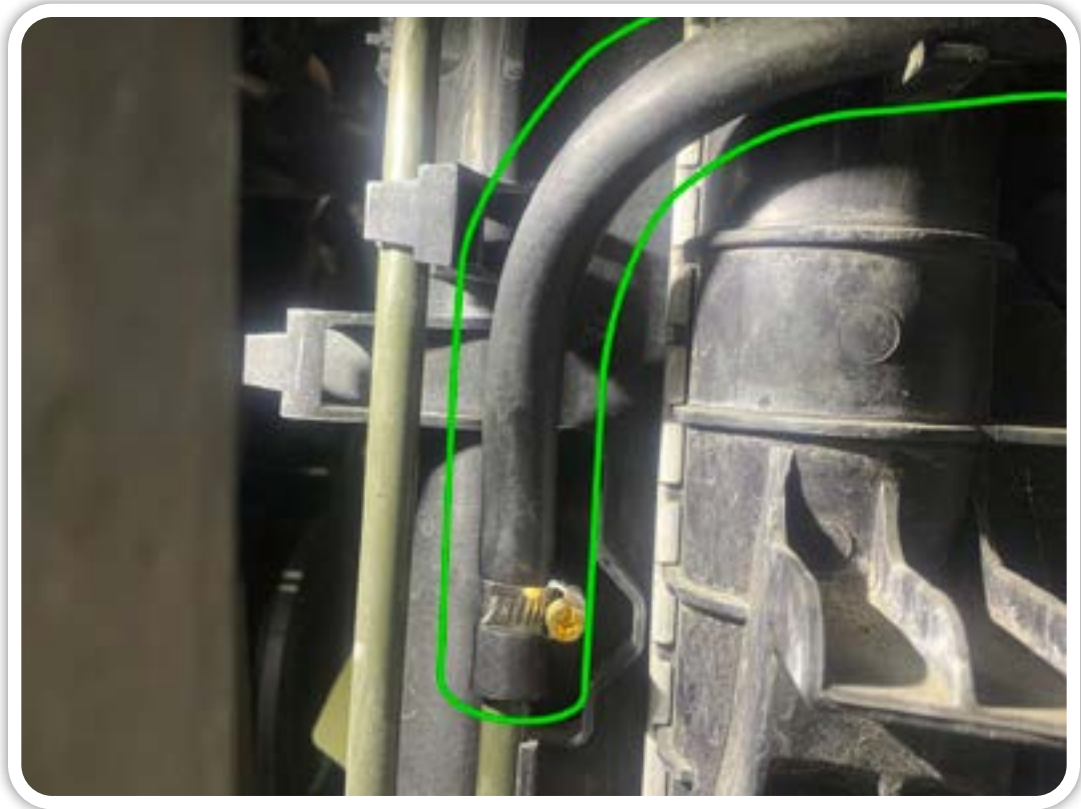

- 11.** Fit the Dual Cooler bracket (with barbs facing the drivers side of the vehicle) to the original horn mounting hole, airbag sensor stud and to the flat section of the radiator support. The radiator support uses a M6x20 SEMS bolt fed from underneath up into the bracket.





- 12.** Fit hose that is coming from the pipe mounted on the radiator to the top of the rear cooler. Cut hose to length and use supplied new hose clamp.

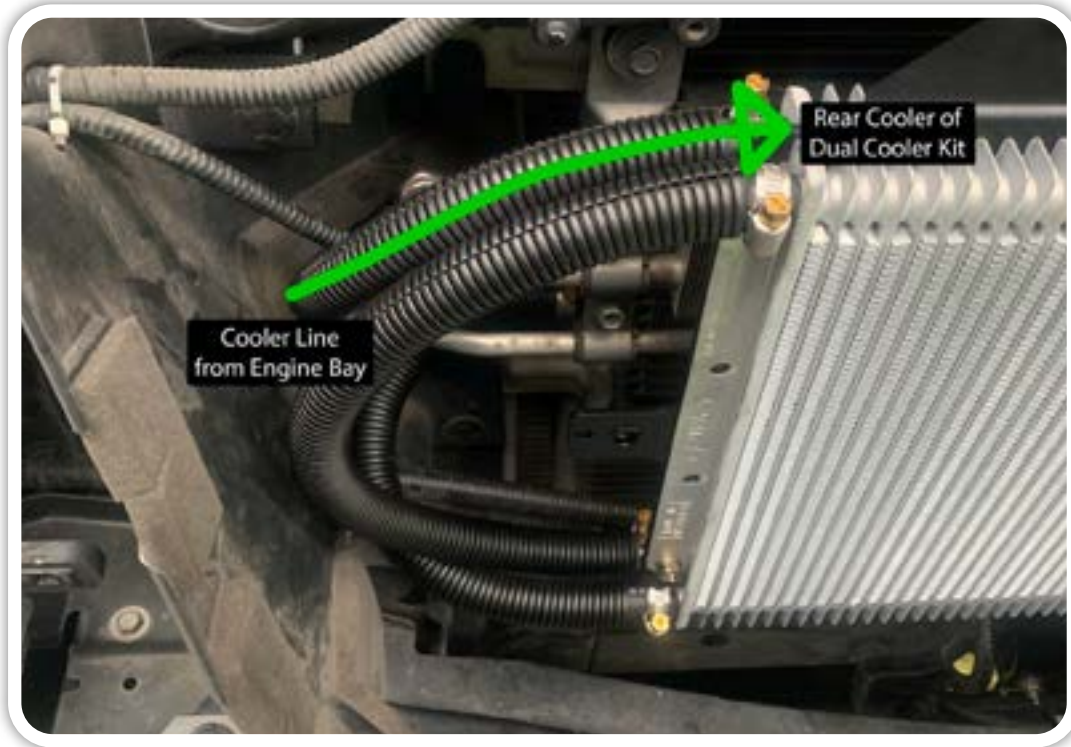

- 13.** Fit hose that is on the OEM transmission cooler to the bottom of the front cooler. Cut hose to length and use supplied new hose clamp.

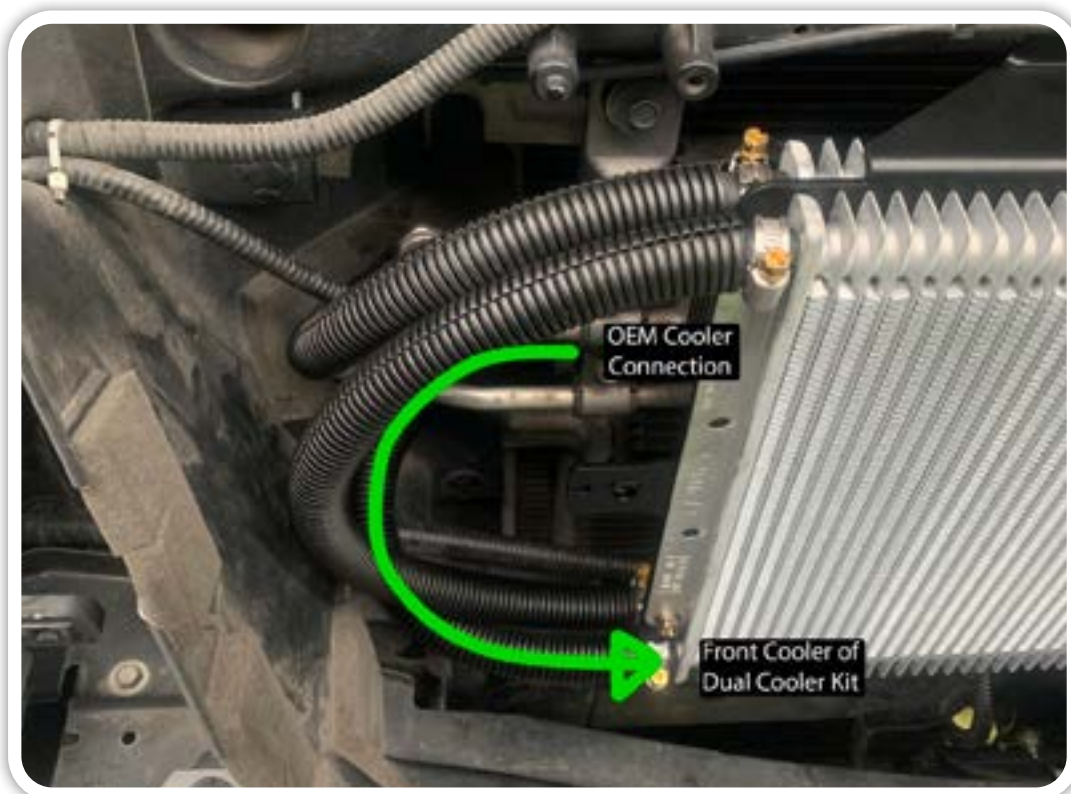

- 14.** Fit supplied 500mm Dual Cooler link hose to join the front cooler to the rear cooler.

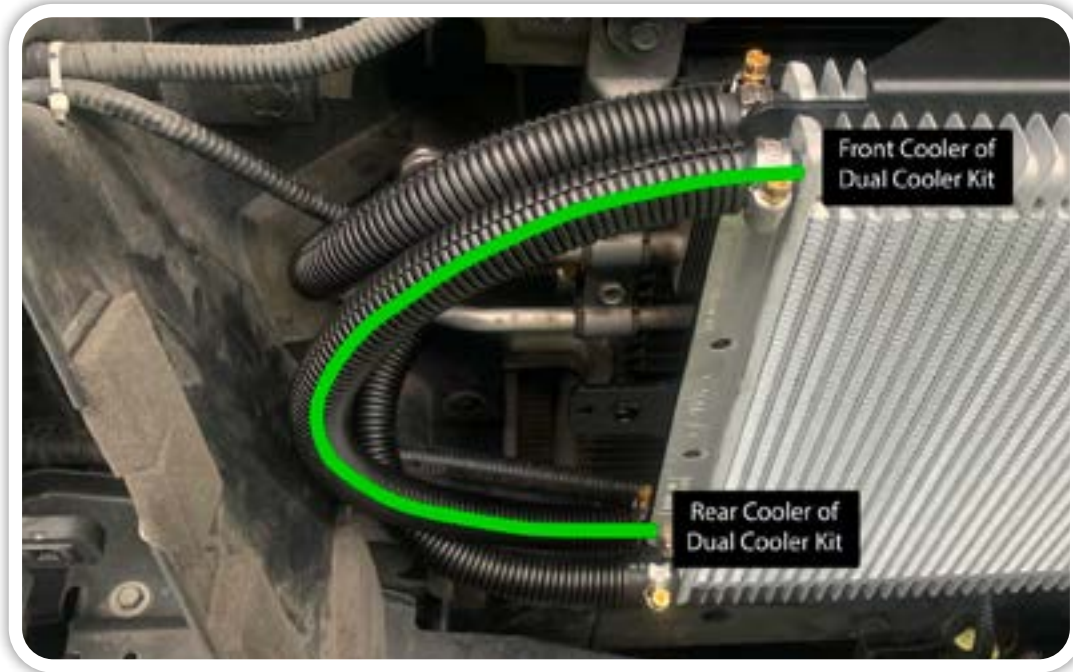

- 15.** Before refitting horn, loosen 10mm nut on the horn and rotate bracket 180° and re-tighten. (Horn outlet needs to be facing down to prevent the chance of water ingress). Then mount horn to the new cooler bracket with supplied M8x20 SEMS bolt. The locator tab should match hole in bracket.



- 16.** Refit battery tray and battery.

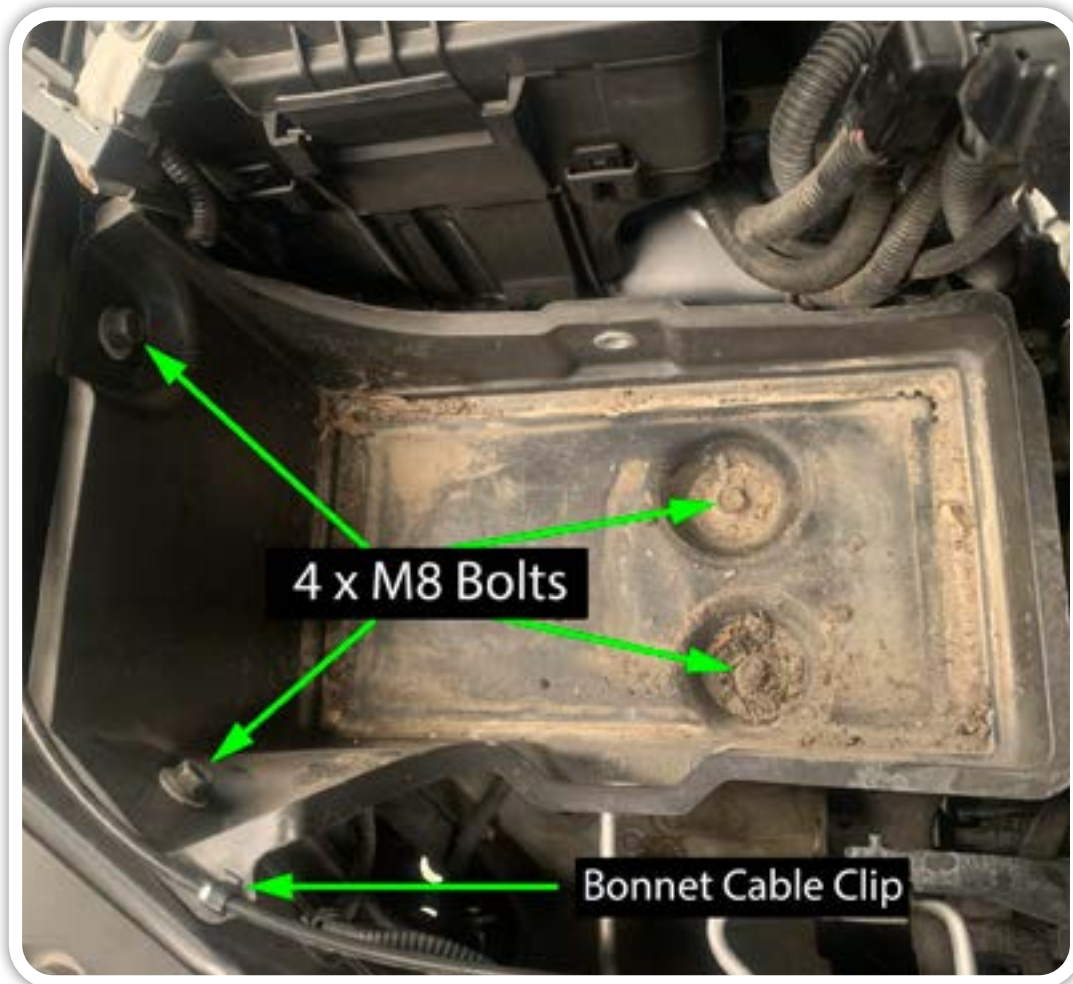

- 17.** Start engine and leave transmission in Park position.

- 18.** Verify there are no leaks coming from any of the connections. If no leaks detected, refit front grill and top radiator shroud by pushing the lower grill clips in first.

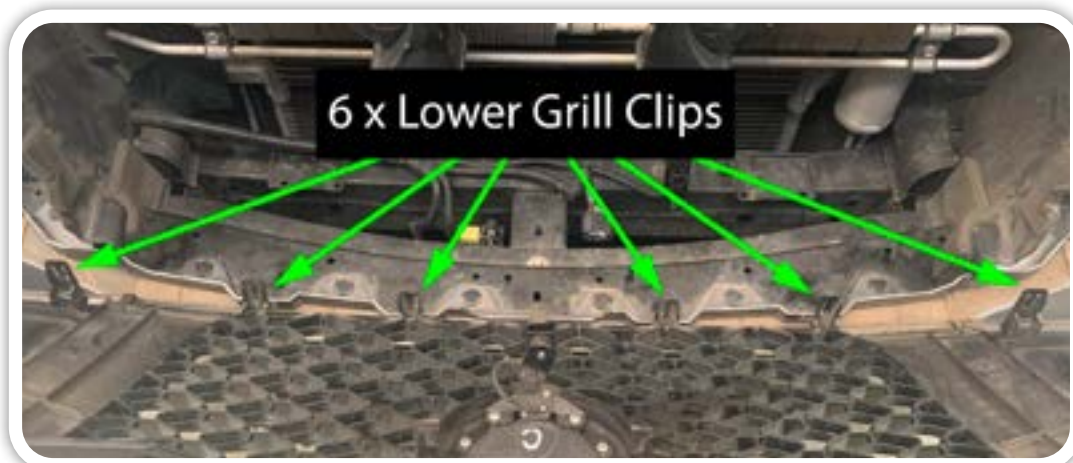

- 19.** Then push fit the remaining clips on the outer edges of the grill and refit the 8 (eight) x grill clips holding the upper cover to the vehicle.

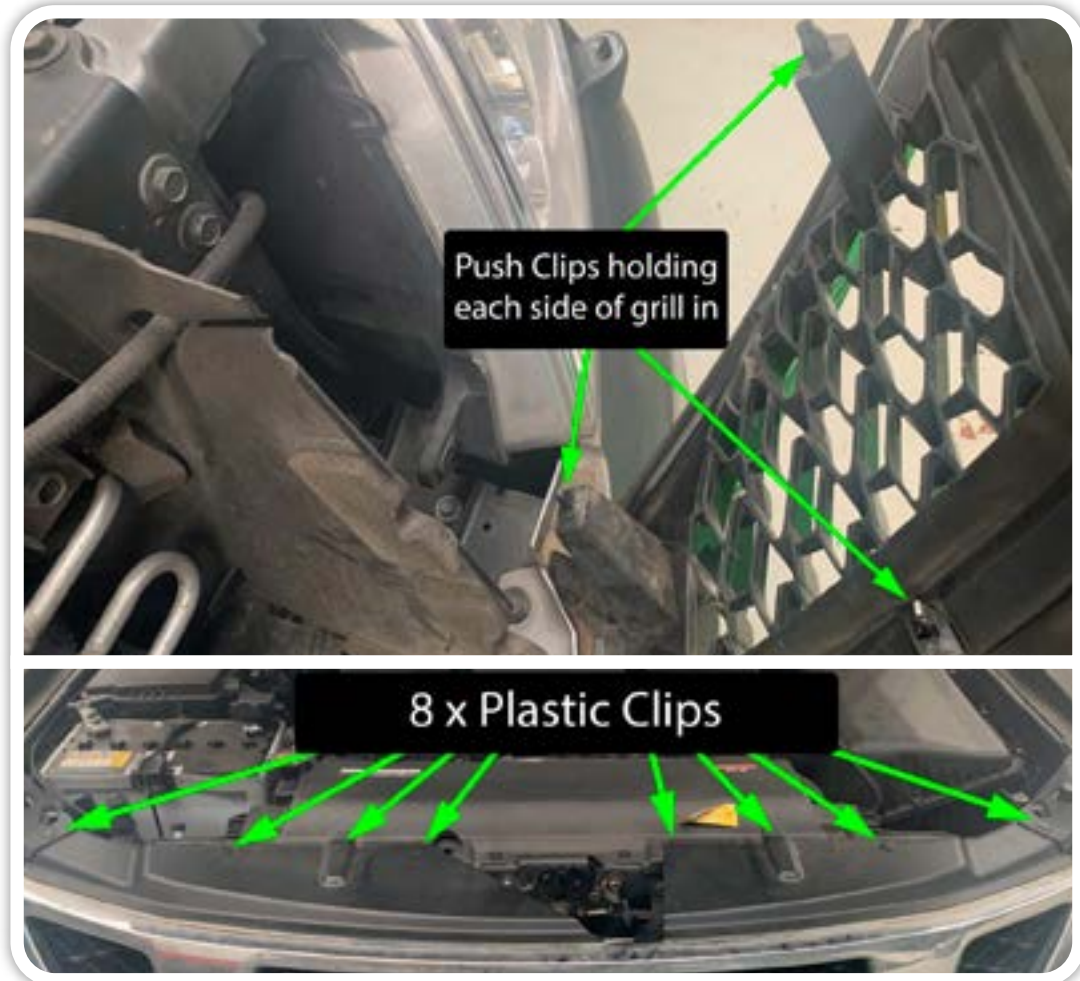

- 20.** The Nissan Patrol Y62 RE7 transmission uses an overflow tube to provide the correct transmission fluid level. This overflow tube is located at the front of the transmission pan and is accessed via the 5mm hex bolt.

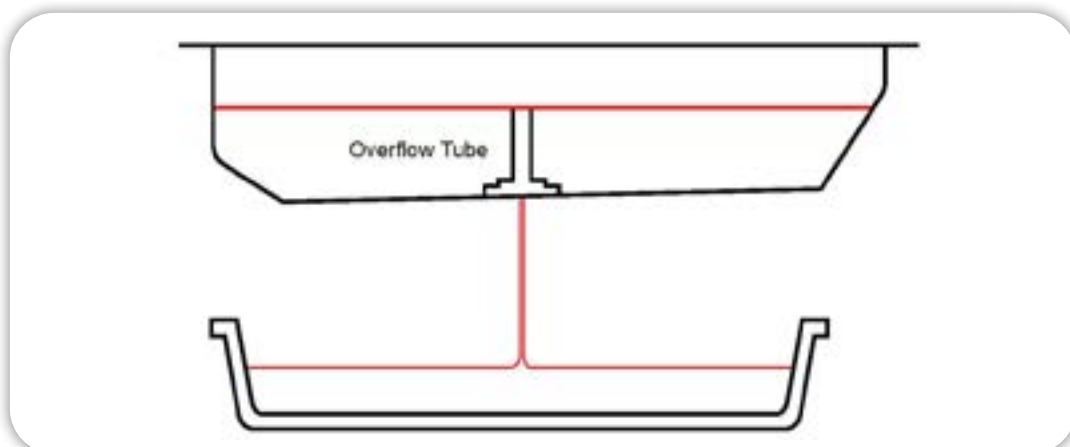

- 21.** Once the engine has been running for at least 1 minute, move a drain tin into place under the overflow outlet and then remove the 5mm hex bolt.

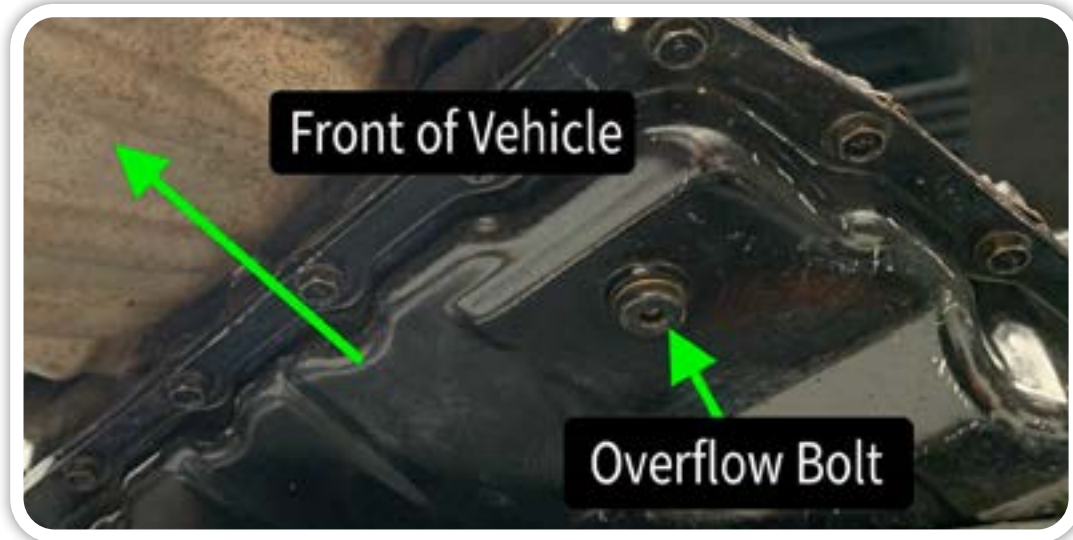

- 22.** If the transmission fluid starts to flow out of the overflow tube in a light but steady stream (as indicated in the image below), then there is sufficient fluid inside the transmission. Wait until it slows to a dribble and re-install the overflow bolt. You can now skip to Step 26.

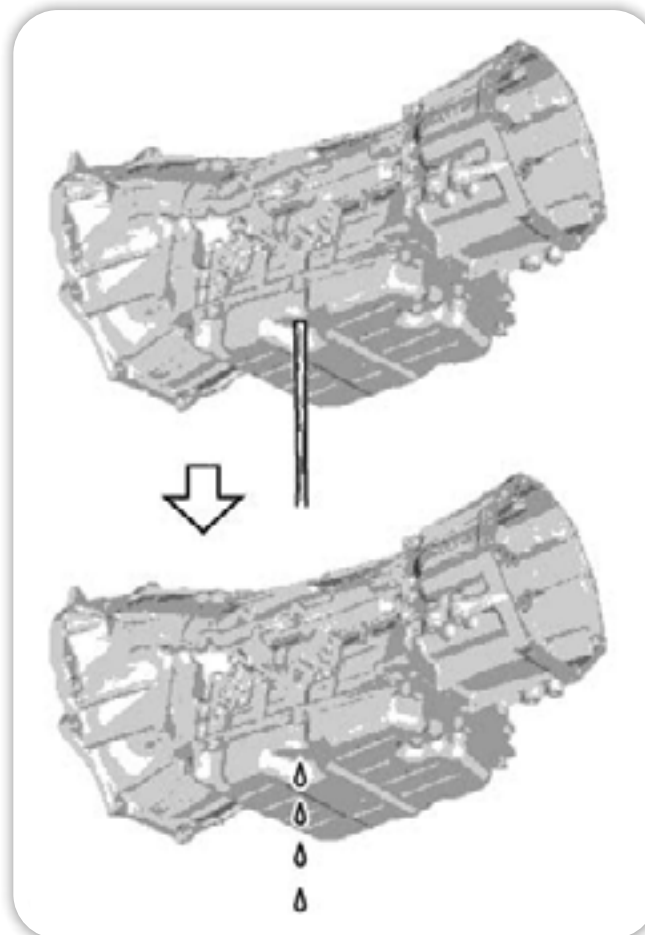
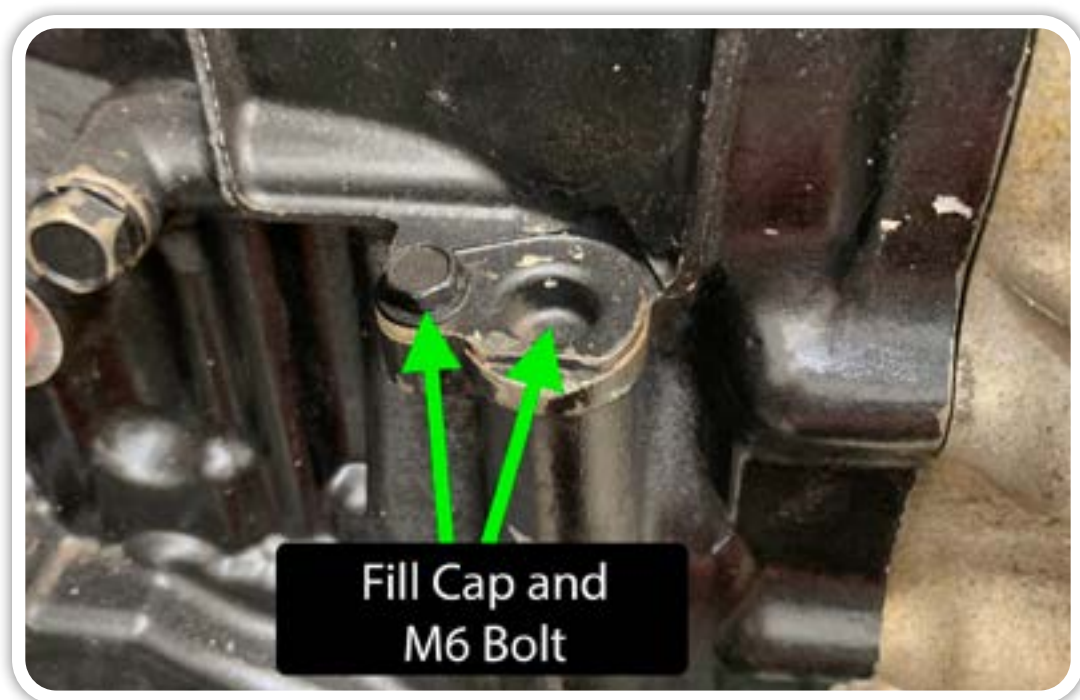

IMAGE IS NOT OF THE NISSAN RE7 TRANSMISSION. THE IMAGE IS TO ILLUSTRATE THE FLOW OF TRANSMISSION FLUID.

23. If there is no fluid flowing/dribbling from the overflow OR there was a small amount of fluid to start with but then stops, this indicates you need to add transmission fluid.
24. To add fluid, remove the M6 bolt holding a cap over the fill hole just above the front of the pan on the drivers side. Add fluid until there is a light but steady dribble out of the overflow tube. If you add too much and you get a stream of fluid, wait until it slows to a dribble.



25. Re-install the overflow tube 5mm hex bolt. Re-install fill cap and M6 Bolt. Tighten both.
26. Take vehicle for a road test to get the transmission fluid up to the correct operating temperature. Try to cover as many different conditions as possible and also ensure that you have driven in every gear. Road testing should last at least 10 minutes.
27. After road test, recheck transmission fluid level is correct. Move a drain tin into place under the overflow outlet and then remove the 5mm hex bolt.

- 28.** *If there is no fluid flowing/dribbling from the overflow OR there was a small amount of fluid to start with but then stops, you have most likely cleared some air pockets and will need to add more transmission fluid. Return to Step 24.*
- 29.** *If the transmission fluid starts to flow out of the overflow tube in a light but steady stream (as indicated in the image below), then there is sufficient fluid inside the transmission. Wait until it slows to a dribble and re-install the overflow bolt. Re-install the fill cap and bolt if these were removed during this process.*

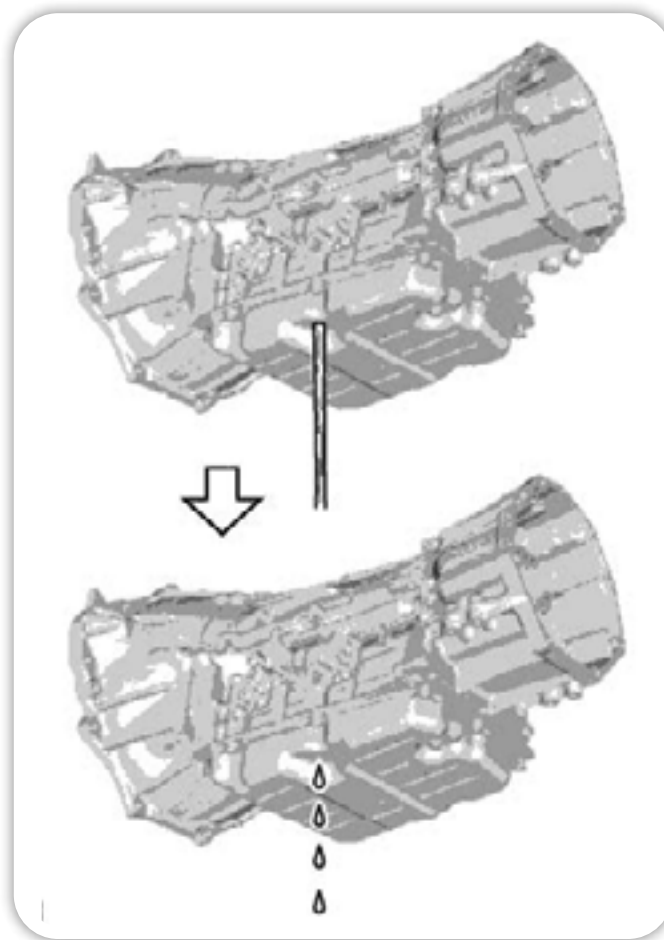

- 30.** *Finally, check again for any leaks from any of the cooler fittings. If you do find a leak, you may need to tighten the clamps.*
- 31.** *Cleanup any spilt fluid on or around the vehicle and refit any other items removed to perform the installation.*

***This completes the installation of the  
Dual External Transmission Oil Cooler Kit to Suit  
Nissan Patrol Y62 with RE7 7 Speed Automatic Transmission***

***PLEASE REMEMBER ALL AUTOMATIC TRANSMISSIONS HAVE A SERVICE INTERVAL OF  
2 YEARS OR 40,000KM TO IMPROVE THE LONGEVITY OF THE TRANSMISSION.***